

### Section 6.1.1. - Flexible JAW Coupling

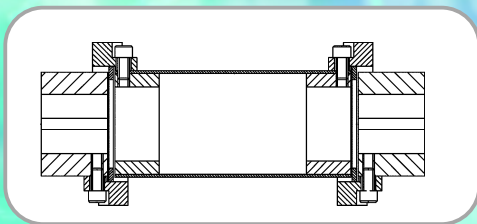

15 Models, Curved Jaw Design  
 Reliable, rugged and compact  
 No need for lubrication  
 Grease and oil resistant  
 Bores sizes up to 110 mm  
 Torque ratings: up to 3300 Nm

### Section 6.1.2. - Flexible Spacer Coupling



7 Model sizes  
 Compact, light and robust  
 2 Metal Hubs and flexible element  
 Easy to install and maintain  
 Bores sizes up to 80 mm  
 Torque ratings: up to 2000 Nm

## 6. couplings and **drive shafts**

### Section 6.1.3. - Steel Flexible Gear Couplings



Flanged or Continuous Sleeve Models  
 Flex-Flex and Flex-Rigid configurations  
 Strong, rugged Steel Couplings  
 High transmittable torque and high maximum speed  
 Bores sizes up to 130 mm  
 Torque ratings: up to 20700 Nm

### Section 6.2.1. - Drive Shafts

### Section 6.2.2. - Plummer Blocks

### Section 6.2.3. - Hand Wheels

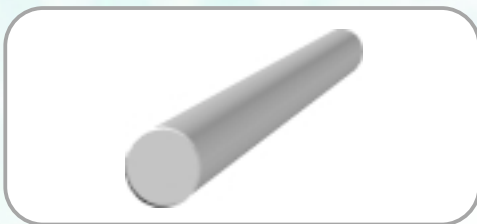

#### Drive Shafts

Standard Drive Shafts with Machine Journals and Keyways  
 Drive Shaft ends can be machined to customer design  
 3 Standard sizes with others on request

#### Plummer Blocks

Rugged, strong, cast iron Plummer Blocks  
 Floating or Locating Bearings  
 One Piece and Split Housing Designs

#### Hand Wheels

Rugged, lightweight Hand Wheels  
 Suitable for manual operation of Gearboxes or Screw Jacks

Power Jacks Group

South Harbour Road, Fraserburgh, Aberdeenshire, AB43 9BZ, Scotland, UK

tel: +44 (0) 1346 513131      fax: +44 (0) 1346 516827  
 email: sales@powerjacks.com      web: www.powerjacks.com



Section Index



**1. Screw Jacks (Mechanical Actuators)**

Cubic Metric Machine Screw Actuators  
Metric and Imperial Machine Screw Actuators  
Stainless Steel Actuators - Metric and Imperial  
Micro-Miniature Actuators  
Ball Screw Actuators - Metric and Imperial  
Roller Screw and Special Actuators



**3. Screw Drives**

Spiracon Roller Screw



**5. Reduction Gearboxes**

Helical Worm Gearboxes  
In-Line Helical Gearboxes



**7. Electric Motors**

Standard 3-Phase Motors  
Brake Motors  
Motors with Encoders and Forced Ventilation



**9. Engineers Reference**

Formulae and Factors  
Standard Metric Component Data  
Properties  
Warranty

**2. Linear Actuators**

EMA - Actuator Series  
Rolaram Actuator Series



**4. Bevel Gearboxes - Neeter Drive**

P-Range Series 2000 and 4000  
N-Range Series 35, 37, 38, 39 and 40  
BA-Range Series L, H, and K

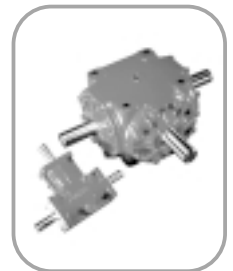

**6. Couplings and Drive Shafts**

Jaw and Gear Flexible Couplings  
Drive Shafts  
Plummer Blocks  
Hand Wheels



**8. Motion Control**

Rotary Limit Switches  
Proximity and Electro-mechanical Limit Switches  
Encoders - Incremental and Absolute  
Position Indicators  
Control Panels





**Picture Index**



*Cubic Actuators*



*Metric Actuators*



*Metric Ball Screw Actuators*



*Stainless Steel Actuators*



*EMA Actuators*



*Ball Screw Rolaram Actuator*

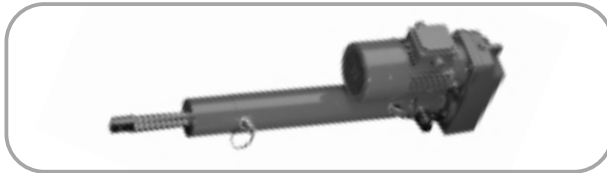

*Roller Screw Rolaram Actuator*



*Special Actuators*



*Imperial Actuators*



*Imperial Ball Screw Actuators*



*Roller Screw and Special Actuators*



*Spiracon Roller Screw*



*P-Range Bevel Gearboxes*



*N-Range Bevel Gearboxes*



*BA-Range Bevel Gearboxes*



*Electric Motors*



*Couplings and Drive Shafts*

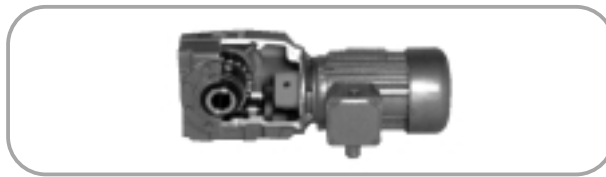

*Helical Worm Gearboxes*



*In-Line Helical Gearboxes*



*Proximity and Contact Limit Switches*



*Rotary Limit Switches*



*Encoders*



*Position Indicators*



*Engineers Reference*

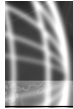

## Company Profile

Power Jacks is the largest and most experienced manufacturer of actuators and mechanical jacks in the UK. With our range of Power Jacks and Duff-Norton actuators you don't just get the product, you also get the knowledge and experience from a company that has, since 1883, manufactured quality industrial lifting, positioning and materials handling equipment.

On our extensive site in Fraserburgh, Aberdeenshire, we have a wide range of engineering facilities including CAD/CAM/CAE technology to aid engineering design and manufacture, an advanced production control system ensuring the optimum product flow through our comprehensive range of conventional and CNC machining facilities, which maximises efficiency and reduces delivery times. This is achieved with our 100+ highly trained employees, giving Power Jacks the capability to produce mechanical engineering of the highest standards.

Quality is a key part of Power Jacks working philosophy and built into the product from initial design conception, through production, to installation and after sales service.

There are over two million of our actuators successfully in operation world-wide. The Power Jacks Group are a global market leader in Linear Actuation Systems.



### *Power Jacks Ltd Extensive Site in Fraserburgh, Aberdeenshire*



By specifying a Power Jacks product you are assured of quality, reliability, performance and value. In the United Kingdom there are a team of highly experienced sales engineers to assist customers with their actuation applications whether on site or by direct communications with the Fraserburgh factory. For overseas customers there is an extensive distributor network world-wide.





**Power Jacks Standard Product Range Covers:-**

- Machine Screw Worm Gear Actuators (Screw Jacks)
- Ball Screw Actuators (Screw Jacks)
- Stainless Steel Actuators (Screw Jacks)
- Micro-Miniature Actuators
- TracMaster Electro-Mechanical Linear Actuators
- EMA Electro-Mechanical Linear Actuators
- Rolaram Electro-Mechanical Linear Actuators
- Mechanical Jacks
- Neeter Drive Bevel Gear Boxes
- Reduction Gear Boxes
- Power Transmissions
- Accessories for Complete Actuator Systems
- Actuator Motion Control Systems
- Track (Rail) Jacks
- Hydraulic Jacks
- Hydraulic Cylinders
- Hydraulic Pumps and Tools

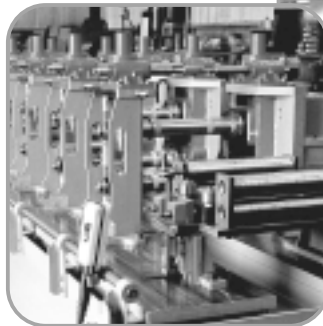

Both Metric and Imperial Products are available.

As well as these standard products Power Jacks has a dedicated engineering team for the design of "Special" products to suit all customer requirements.

These products can be provided as individual parts or single or multiple systems with full engineering consultancy available as part of the service.

For more information contact:

**Power Jacks Ltd**  
South Harbour Road Fraserburgh AB43 9BZ  
Tel: +44 (0) 1346 513131  
Fax: +44 (0) 1346 516827  
email: [sales@powerjacks.com](mailto:sales@powerjacks.com)  
Internet: <http://www.powerjacks.com>



## Company Profile

The Power Jacks Group is an engineering group focused on providing customers with the best solution for precision linear actuation, power transmission, mechanical jacking, hydraulic jacking and engineering service. The engineering history of the group dates from 1883 and the products and service are supplied to customers world-wide.

### The Power Jacks Group Brings Together

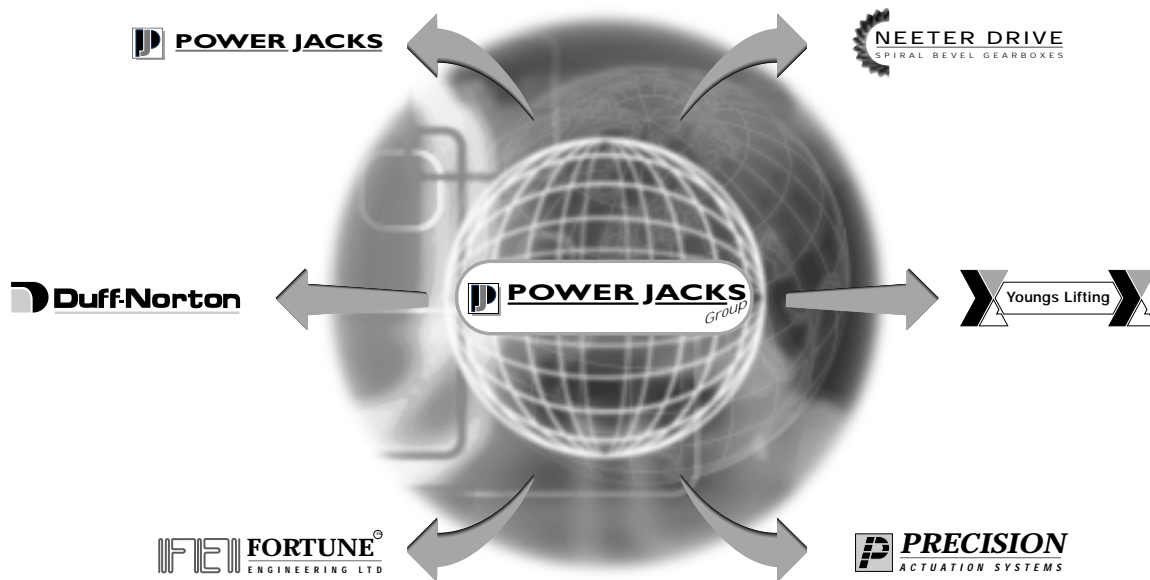

### Representation





## Contents

<b>6.1.</b>	<b>Jaw and Geared Flexible Couplings</b>	<b>2</b>
	6.1.1. Flexible Jaw Couplings	3
	6.1.2. Flexible Spacer Couplings	4
	6.1.3. Steel Flexible Gear Couplings	5
<b>6.2.</b>	<b>Drive Shafts and Plummer Blocks</b>	<b>7</b>
	6.2.1. Drive Shafts	7
	6.2.2. Plummer Blocks	9
	6.2.3. Hand Wheels	10



## 6.1. Jaw and Geared Flexible Couplings

### Selection of Coupling Type

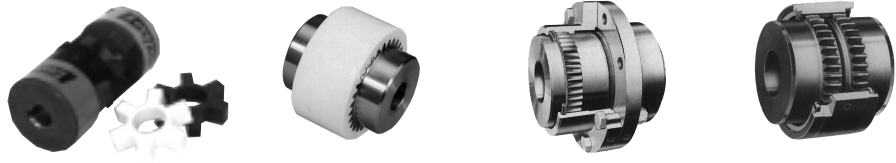

The selection of coupling type depends on the installation and the type of misalignment. The three main types of misalignment encountered are:-

1. Angular Misalignment is usually present to some extent on all applications, typical values 1° - 2°. Sometimes higher values are necessary.
2. Parallel (Radial) Misalignment is also nearly always present. A well aligned installation might have values below 0.25 mm.
3. Axial Misalignment (End Float) sometimes caused by thermal expansion or as a result of machine design.

### Other considerations include:

- Backlash Free Couplings are either one part couplings or have bolted joints. These are effective for precise positioning and to avoid wear on reversing drives.
- Torsional rigidity of couplings depends on the joining method. Types with rubber or plastic elements can be considered as torsionally soft and will have an amount of twist at rated torque.

### Procedure:

1. Decide if the coupling should be torsionally soft or rigid.
2. Consider whether a small amount of backlash is acceptable.
3. Calculate the required coupling torque.
4. Make a provisional selection.
5. Check that the coupling's maximum speed is sufficient.
6. Check that the coupling's dimensions are acceptable.
7. Contact Power Jacks with your order or technical enquiry

### Selection of Coupling Size

$$\text{Coupling Torque, } T(\text{Nm}) = \frac{9550 * \text{Power Transmitted (kW)} * S}{\text{RPM}}$$

where S = Service Factor - dependant on drive conditions (refer to each coupling)

Select the coupling which is rated above the calculated torque. If a brake is present in the system the coupling should be based on either the brake torque or the transmitted torque whichever is greater.

### General Notes

1. Maximum misalignment values are extremes and should not be combined. As operating misalignment approaches the maximum, torque and power ratings should be reduced to maintain life.
2. Gear couplings accommodate parallel misalignment by converting it to angular misalignment at the gear meshes in the flexible halves of the coupling.
3. The maximum axial misalignment values apply when the coupling is aligned. If axial misalignment greater than the listed maximum is required, consult Power Jacks.
4. The inertia values includes shafts through the bores.
5. When ordering please quote the coupling size and type, specify the bore and keyway sizes, and advise if puller holes or set-screws are required.
6. For maximum performance, the actuators, shafts, gear boxes and motor should be carefully aligned.
7. Imperial couplings on request.

Keyways	Metric	Imperial
Standard Bores	B.S. 4500 I 969 H7	B.S. I 916 Part I I 953 K7
Standard Keyways	B.S. 4235 Part I I 967 P9	B.S. 46 Part I I 958



## 6.1.1. Jaw Type Flexible Coupling

- Curved jaw design.
- No need for lubrication.
- Quick and simple to install.
- Reliable, rugged and compact.
- Smooth, silent action.
- High power transmission density.
- 4 Standard spider types available.
- Elastomeric element resistant to heat (-40°→+90°c), grease, oil and chemical agents.
- Hubs in aluminium and sintered iron.

Size		14	19/24	24/30	28/38	38/45	42/55	48/60	55/70	65/75	75/90	90/100	100/110
Torque (Nm)	Nominal, $T_{kn}$	P	10	35	95	190	265	310	375	425	975	2400	3300
	Max $T_{kmax}$	P	20	70	190	380	530	620	750	850	1950	4800	6600
	Vibrating $T_{kw}$ (10Hz)	P	2.6	9	25	49	69	81	93	111	254	624	858
Misalignment Values	Axial (mm)	P	1.2	1.4	1.5	1.8	2	2.1	2.2	2.6	3	3.4	3.8
	Angular (deg)	P	0.9	0.9	0.9	1	1	1.1	1.1	1.2	1.2	1.2	1.2
	Radial (mm)	P	0.2	0.22	0.25	0.28	0.32	0.36	0.38	0.42	0.48	0.5	0.52
Speed	Max (rpm)	P	14000	10600	8500	7100	6000	5600	4750	4250	3550	2800	2500

**Note** All couplings use 92 Shore elastomeric element (white) as standard. 80, 98 and 95 available on request.  
 Maximum torque must not be exceeded during start-up operation.  
 More accurate alignment will increase coupling life and reduce vibration. Dimensions "E" and "L" must be observed.  
 P = Consult Power Jacks for more details.

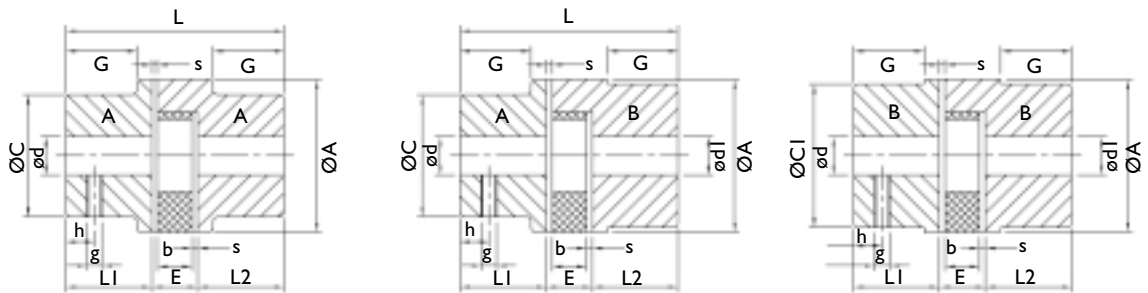

Type	Hub 'A'			Hub 'B'			Dimensions (mm)													Weight kg
	Pre Bore	Min Bore	Max Bore	Pre Bore	Min Bore	Max Bore	A	C	CI	L	L1 & L2	E	s	b	G	F	g	h		
<b>Aluminium Hub Couplings</b>																				
19/24	6	6	19	18	20	24	40	31	38	66	25	16	2	12	20	18	M5	10	0.11	
24/30	6	8	24	22	25	30	55	39	48	78	30	18	2	14	24	27	M5	10	0.24	
28/38	9	10	28	26	30	38	65	46	61	90	35	20	2.5	15	28	30	M6	15	0.42	
38/45	12	14	38	36	40	45	80	64	75	114	45	24	3	18	38	38	M6	15	0.86	
<b>Cast Iron Hub Couplings</b>																				
19/24	-	-	-	-	6	24	40	-	40	66	25	16	2	12	-	18	M5	10	0.34	
24/30	-	-	-	-	8	32	55	-	55	78	30	18	2	14	-	27	M5	10	0.9	
28/38	-	-	-	-	10	38	65	-	65	90	35	20	2.5	15	-	30	M6	15	1.5	
38/45	-	14	38	-	40	45	80	66	78	114	45	24	3	18	37	38	M8	15	2.35	
42/55	-	16	42	-	45	55	95	75	93	126	50	26	3	20	40	46	M8	20	3.55	
48/60	-	19	48	-	50	60	105	85	103	140	56	28	3.5	21	45	51	M8	20	4.85	
55/70	-	22	55	53	60	70	120	98	118	160	65	30	4	22	52	60	M10	20	7.4	
65/75	-	25	65	63	70	75	135	115	133	185	75	35	4.5	26	61	68	M10	20	10.8	
75/90	-	30	75	73	80	90	160	135	158	210	85	40	5	30	69	80	M10	25	17.7	
90/100	-	-	-	-	45	100	200	-	170	245	100	45	5.5	34	81	100	M10	25	29.6	
100/110	-	-	-	-	45	110	225	-	180	270	110	50	6	38	89	113	M12	30	39	

**Note** Weight of min. bored coupling with standard A/B hub combination.  
 All couplings metric bored and keyed as standard. Consult Power Jacks for standard bore sizes and specials.

**Service Factor**  $S = F_t * F_z * F_s$

Temperature (°C)	-30°C to +30°C	40°C	60°C	80°C
Temperature Factor ( $F_t$ )	1	1.2	1.4	1.8

Starts/Day	0 to 10	101 to 200	201 to 400	401 to 800
Starting Factor ( $F_z$ )	1	1.2	1.4	1.8

Shock Type	None	Light	Medium	High
Shock Factor ( $F_s$ )	1	1.5	1.8	2.5

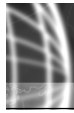

### 6.1.2. Flexible Spacer Couplings

- Compact, light, robust, safe in operation, long service life.
- Two identical hubs and one flexible element.
- Hubs of high tensile steel.
- Large permissible bores, various hub lengths.
- Driving dogs have smooth surface, high durability.
- Generously proportioned compression-stressed flexible inserts.
- Damps vibrations and shocks, compensates for axial, radial and angular misalignment.

#### Elastomeric Element features:

- Inserts made of "90 Shore A" Polyurethane (G) as standard or tough "55 Shore D" Hytrel (H).
- Operating temperature range: -40°C → +80°C as standard
- Elastomeric element is resistant to oil and grease.

#### Coupling Performance

Type Size	B-G			B-H-G			Max Speed N <sub>max</sub> (rpm) Elastomeric Element
	Nominal Torque T <sub>KN</sub> (Nm)	Maximum Torque T <sub>Kmax</sub> (Nm)	Torsional Angle (deg) at T <sub>KN</sub>	Nominal Torque T <sub>KN</sub> (Nm)	Maximum Torque T <sub>Kmax</sub> (Nm)	Torsional Angle (deg) at T <sub>KN</sub>	
72	32	64	4	45	80	2,5	10000
76	63	125	4	90	125	2,5	9000
98	125	250	4	175	280	2,5	7500
120	250	500	4	350	560	2,5	6000
138	400	800	4	560	900	2,5	5000
165	600	1200	4	850	1700	2,5	4000
185	1000	2000	4	1400	2800	2,5	3600

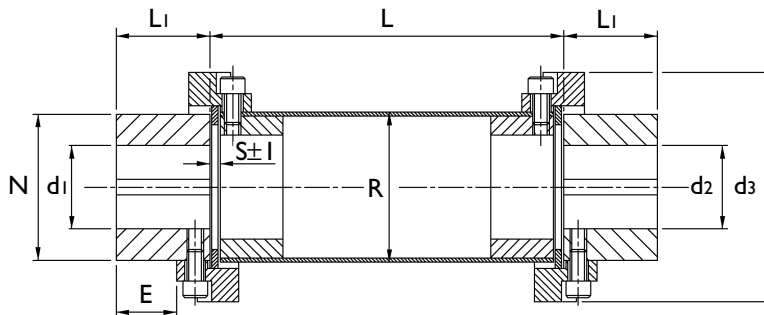

#### Coupling Dimensions

Size	d min (d1, d2)	d max (d1, d2)	d3	E	L1	N	R	S +/- I	Model
72	9	30	72	14	28	50	45	6	CF-B-(H)-72-G-L=*
76	12	30	76	16	30	50	45	6	CF-B-(H)-76-G-L=*
98	12	38	98	24	42	61	60	6	CF-B-(H)-98-G-L=*
120	15	48	120	28	50	71	70	6	CF-B-(H)-120-G-L=*
138	15	55	138	30	55	86	85	6	CF-B-(H)-138-G-L=*
165	20	65	165	36	65	100	100	8	CF-B-(H)-165-G-L=*
185	30	80	185	45	80	115	115	10	CF-B-(H)-185-G-L=*

Note All dimensions in mm. \*Insert length L here in millimetres.

#### Misalignment

Element Type	Radial (mm)	Axial (mm)	Angular (deg)
B - Standard	0.5	+/- I	I
H - Hytrel	0.25	+/- I	0.5

Note The best possible alignment will result in the best coupling performance.

#### Service Factor

The service factor must be chosen according to working conditions between 1 (light duty) and 3 (arduous duty).

#### Critical Speed & Spacer length

Spacer coupling lengths can be provided up to a maximum of 6m depending on rotational speed. For advice on the critical speed of a given coupling consult Power Jacks.



## 6.1.3. Steel Flexible Gear Couplings

Nature of Load on Unit	Uniform	Light Shock	Medium Shock	Heavy Shock
Service Factor, S	1.0	1.25	1.50	2.0

- Note**
1. All dimensions in millimetres.
  2. Dimension 'R' and 'CAC' are the clearance required to align the coupling when installing.
  3. These couplings are designed for grease lubrication. A list of suggested lubricants and quantities is detailed in the installation manual supplied with each full coupling.
  4. Where a coupling is exposed to sustained temperatures above 100°C (212°F) a coupling with high temperature seals must be used, consult Power Jacks Ltd.

### 6.1.3.1. Continuous Sleeve Steel Gear Coupling

- Vari-crown tooth form for improved torque transmission and longer life.
- Strong compact design.
- High transmittable torque ratings.
- Low inertia and high maximum speeds.
- Steel reinforced high misalignment seals.
- Spacer couplings available on request.

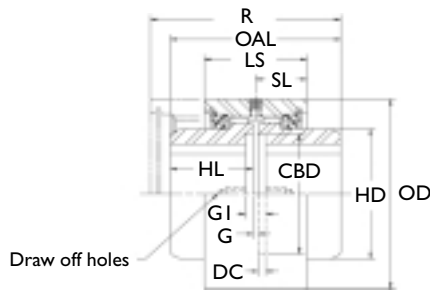

**Full-Flex Gear Coupling**

Two flexible hubs and sleeve assembly.  
Accommodates angular, parallel and axial misalignments.

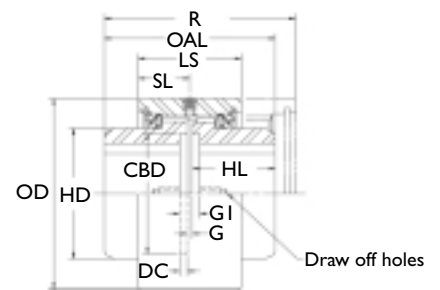

**Flex-Rigid Gear Coupling**

Flexible and rigid hub assembly. The flexible hub is standard and the rigid hub is splined into the sleeve.  
Accommodates angular and axial misalignment only.

Coupling Size and Type		Full-Flex	CFF022	CFF038	CFF050	CFF065	CFF075	CFF090	CFF100	CFF115
		Flex-Rigid	CFR022	CFR038	CFR050	CFR065	CFR075	CFR090	CFR100	CFR115
Rated Torque (Nm)			285	854	2278	3417	5695	9967	14238	20787
Rated Power (kW/100 rpm)			3	8.9	23.8	35.8	59.6	104.4	149	217.7
Maximum Speed Unbalanced* (rpm)			6000	5000	4200	3750	3000	2800	2400	2200
Full	Maximum	Parallel	0.13	0.18	0.18	0.25	0.30	0.30	0.18	0.18
	Misalignment	Angular	1°	1°	1°	1°	1°	1°	1°	1°
Flex	Maximum	Axial (+/-)	0.3	0.3	0.3	0.6	0.6	0.6	0.6	0.6
		Angular	0.5°	0.5°	0.5°	0.5°	0.5°	0.5°	0.5°	0.5°
Rigid	Misalignment	Axial (+/-)	0.3	0.3	0.3	0.6	0.6	0.6	0.6	0.6
		(kg m <sup>2</sup> )	0.002	0.004	0.010	0.022	0.053	0.112	0.225	0.376
Weight (Rough Bore)		(kg)	2.3	3.6	5.9	9.1	15	29	41	57
Maximum	Bore		31	42	56	70	84	97	111	130
	Keyway	(b x h)	8 x 7	12 x 8	16 x 10	20 x 12	22 x 14	28 x 16	28 x 16	32 x 18
Rough Bore			11	15	18	22	30	32	44	60
DD			84	95	121	140	168	191	222	241
HD			51	60	83	100	121	137	159	184
HL			38	46	52	57	67	108	111	127
G			3	3	3	6	6	6	6	6
GI			10	13	13	19	19	19	19	19
OAL			80	95	108	121	140	222	229	260
R			95	117	124	145	175	235	241	264
LS			51	64	65	78	95	102	118	124
DC			3	5	5	6	6	6	6	6
CBD			49	57	76	95	121	140	165	184
SL			25	32	33	39	48	51	59	62

- Note**
- \*Balanced speed approximately 3 times higher.
  - Draw off holes are optional, consult Power Jacks.
  - All dimensions in millimetres.



### 6.1.3.2. Flanged Sleeve Steel Gear Coupling

- High transmittable torque ratings and high maximum speeds.
- Accommodates angular, parallel and axial misalignment.
- Strong forged steel hubs and sleeves.
- Vari-crown tooth form for improved torque transmission and longer life.
- Several mounting options available by reversing the hubs.
- Spacer gear couplings available. Consult Power Jacks.

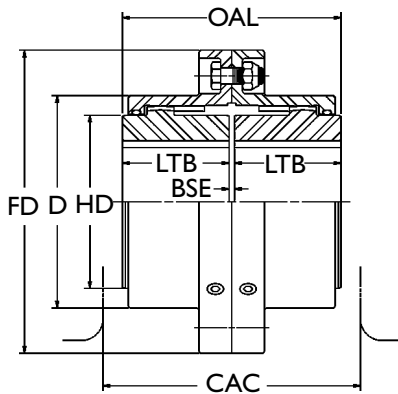

**Full-Flex Gear Coupling**

Two flexible hubs and sleeve assembly. Accommodates angular, parallel and axial misalignments.

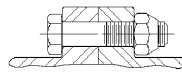

Exposed bolt design also available.

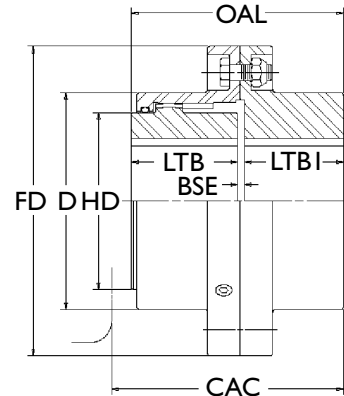

**Flex-Rigid Gear Coupling**

Flexible and rigid hub assembly. Accommodates angular and axial misalignment only.

Coupling Size and Type		Full-Flex	FFF025	FFF038	FFF050	FFF065	FFF075	FFF090	FFF100
		Flex-Rigid	FFR025	FFR038	FFR050	FFR065	FFR075	FFR090	FFR100
Rated Torque (Nm)			859	2136	3560	6407	10679	17086	24917
Rated Power (kW/100 rpm)			8.9	22.3	37.3	67.1	111.9	179	261
Maximum Speed Unbalanced * (rpm)			6000	5500	5000	4400	4000	3500	3000
Full Flex	Maximum Misalignment	Parallel	1.4	1.5	2.2	2.7	2.9	3.3	3.8
	Angular	Angular	3°	3°	3°	3°	3°	3°	3°
Flex Rigid	Maximum Misalignment	Angular	1.5°	1.5°	1.5°	1.5°	1.5°	1.5°	1.5°
	Axial (per hub)	Axial (per hub)	1.5	1.5	1.5	2.2	2.2	2.2	3.3
Inertia (kg.m <sup>2</sup> )	Full Flex	Full Flex	0.006	0.019	0.044	0.100	0.192	0.435	0.80
	Flex Rigid	Flex Rigid	0.006	0.020	0.044	0.106	0.203	0.446	0.831
Weight (Rough Bore) (kg)	Full Flex	Full Flex	4	9	15	25	36	59	86
	Flex Rigid	Flex Rigid	4	8	15	25	39	61	89
Maximum (Flexible Ends)	Bore		42	56	73	88	107	124	147
	Keyway (b x h)		12 x 8	16 x 10	20 x 12	25 x 14	28 x 16	32 x 18	36 x 20
Maximum (Rigid End)	Bore		56	76	95	114	134	150	176
	Keyway (b x h)		16 x 10	20 x 12	25 x 14	32 x 18	36 x 20	36 x 20	45 x 25
Rough Bore	FF		11	18	24	37	37	46	62
	FR								
Solid with Centre									
OAL			89	102	127	159	187	219	248
FD			116	152	178	213	240	279	318
D			78	101	125	150	176	201	235
HD			59	76	102	118	143	165	191
LTB			43	49	62	77	91	106	121
LTBI			40	47	58	74	87	101	113
BSE	FF		3	3	3	5	5	6	6
	FR		4	4	4	5	5	6	8
OAL	FF		89	102	127	159	187	219	248
	FR		87	100	124	156	183	213	241
CAC	FF		106	121	152	181	207	238	260
	FR		95	109	137	167	192	222	248
Flange Thickness per Hub			14	19	19	22.5	22.5	29	29

**Note** \*Balanced speed approximately 3 times higher. Consult Power Jacks for details.  
 Draw off holes are optional, consult Power Jacks.  
 All dimensions in millimetres.



## 6.2. Drive Shafts and Plummer Blocks

### 6.2.1. Selection Guidelines

#### 1. Select Drive Shaft Diameter

Select a standard drive shaft from the drive shaft table (refer 6.2.1.1.) and check its torque rating and angle of twist rating against the application requirements.

if Transmitted Torque (Nm) < Maximum Drive Shaft Torque (Nm)

&

if Acceptable Angle of Twist (Deg.) for shaft length < Rated Angle of Twist for Drive Shaft (Deg.)  
then drive shaft diameter selected is acceptable.

#### 2. Check Drive Shaft Critical Speed

For the unsupported shaft length calculate the drive shaft critical speed for the support conditions required (refer 6.2.1.2.).

If Shaft Speed (rpm) < Drive Shaft Critical Speed (rpm)  
then drive shaft selection and configuration is acceptable.

#### 2(a). Plummer Block Selection

If the drive shaft fails due to the critical speed reduce the unsupported drive shaft length using plumber blocks.

e.g. one plumber block at each end of the drive shaft and one in the middle, reducing the unsupported length to half the total drive shaft length.

Select a plumber block from the table relating to the appropriate shaft diameter size (refer 6.2.2.).

Re-calculate the critical speed for the new unsupported length and check for acceptability.

If space constraints restrict the number of plumber blocks and the drive shaft fails on the critical speed try increasing the shaft diameter to the next size up or consult Power Jacks for detailed analysis.

- Note**
1. For other shaft and plumber block sizes and styles consult Power Jacks Ltd.
  2. For detailed shaft analysis and selection consult Power Jacks Ltd.

#### 6.2.1.1. Standard Drive Shafts

There are three standard drive shaft sizes offered by Power Jacks with ends machined to suit actuator system couplings however drive shafts can be supplied to customer sizes with specific end designs

Standard Drive Shafts	Rated Torque (Nm)	Rated Angle of Twist per Metre (Degrees)
20mm Diameter	85	4
30mm Diameter	285	2.6
40mm Diameter	675	2

- Note**
1. For other drive shaft types and sizes consult Power Jacks Ltd.
  2. For detailed analysis consult Power Jacks Ltd.
  3. Dimensions subject to change without notice.



### 6.2.1.2. Drive Shaft Critical Speed

Drive Shaft Critical Speed Factors,  $F_{dcs}$



$$\text{Allowable Drive Shaft Speed (rpm)} = \frac{\text{Critical Speed (rpm) for Unsupported Length "L" (from chart below)}}{F_{dcs}} \times F_{dcs}$$

If Shaft Speed (rpm) < Drive Shaft Critical Speed (rpm) then drive shaft selection and configuration is acceptable.

**DRIVE SHAFT CRITICAL SPEED GRAPH  
(Shaft Whirling)**

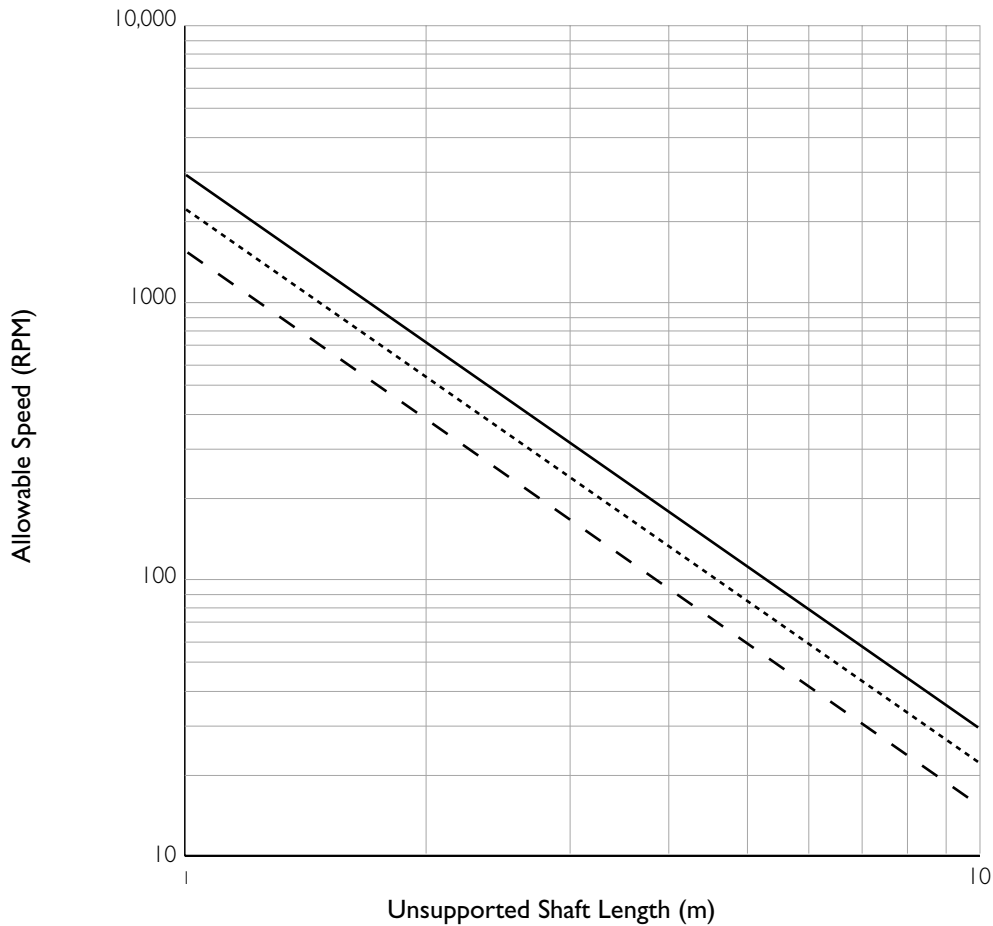

Based on simply supported both ends and 70% of the critical speed.  
(The factor of safety allows for couplings and slight misalignment)

LEGEND		
---	.....	—
20mm Diameter	30 mm Diameter	40 mm Diameter



**6.2.2. Plummer Blocks**

**6.2.2.1. One Piece Housing Plummer Block**

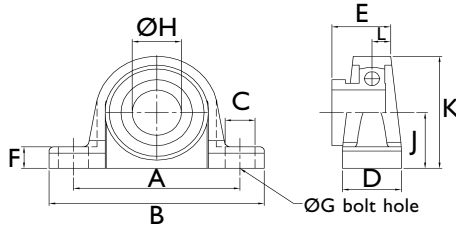

Model	A	B	C	D	E	F	G	H	J	K	L	Weight (kg)
PBI-20	96	127	20.5	32	34	14	10	20	33.33	65	10.5	0.6
PBI-30	121	152	23.5	40	39.2	17	12	30	42.9	82.5	12.5	1.1
PBI-40	136	175	24.5	48	47.7	19	12	40	49.2	99	15	1.9
PBI-50	159	203	26	54	49.7	22	16	50	57.2	115	17	2.8
PBI-60	186	240	29.5	60	60.5	26.5	16	60	69.9	138	21	4.5

- Notes**
1. All dimensions in mm.
  2. Bore diameter tolerances: (H6+H7)/2.
  3. Material: Cast Iron housing with eccentric locking ring.
  4. Dimensions are subject to change without notice.
  5. For other styles and sizes of Plummer Blocks consult Power Jacks Ltd.

**6.2.2.2. Split Housing Plummer Block**

Plummer blocks are to DIN736 with anti-friction bearings with tapered bores and adapter sleeve. The housings are made of cast iron and are sealed with felt strips on both sides. The housings are designed to allow floating or located bearings (bearing position set with one or two locating rings).

It is recommended when arranging drive systems only one plummer block with located bearing is used in one drive line, to avoid distortion of the drive.

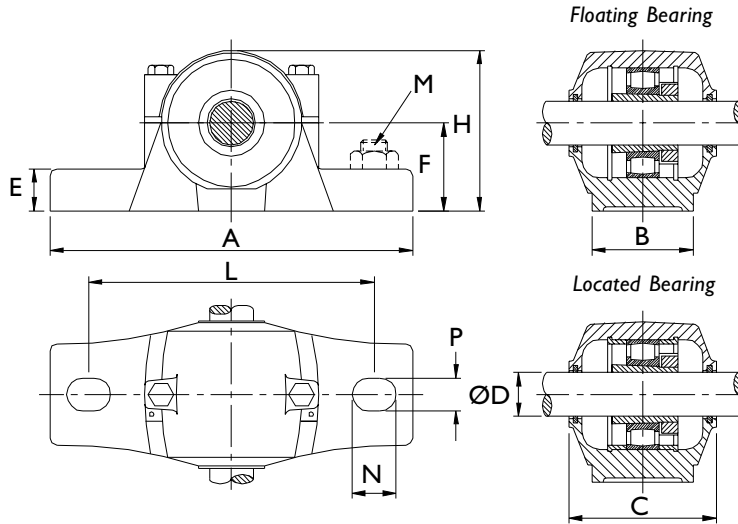

Model	ØD	A	B	C	E	F	H	L	M	N	P	Weight (kg)
PB20	20	165	46	67	19	40	72	130	M12	20	15	1.4
PB30	30	185	52	80	22	50	92	150	M12	20	15	2
PB40	40	205	60	82	25	60	109	170	M12	20	15	2.9

- Note:-**
1. All dimensions in mm.
  2. For other styles and sizes of Plummer Blocks consult Power Jacks Ltd.
  3. Dimensions are subject to change without notice.



### 6.2.3. Hand Wheels

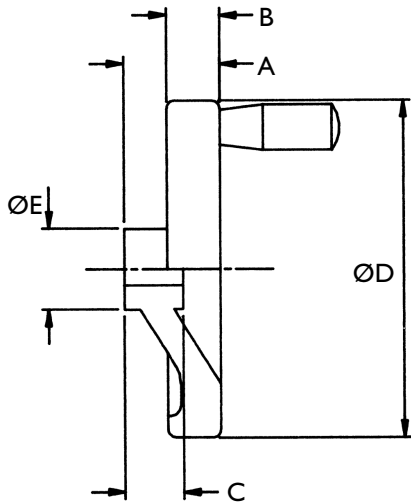

Model	A	B	C	D	E	H7 Bore
HW 005	40	14	36	98	24	10
HW 010	50	22	38	157	32	14
HW 025	56	24	43	198	40	16
HW 050	56	24	43	198	40	19
HW 100	66	30	44	247	49	25

- Notes:**
1. Material: Polished aluminium casting and rotating handle.
  2. Bored and keyed to BS4235 Part 1.
  3. All dimensions in millimetres unless otherwise stated.
  4. Dimensions subject to change without notice.
  5. Other types of hand wheels are available on request. Consult Power Jacks.