



















Performance

Series 35		
Torque (Nm)	Nominal#1	46
	Max Running#2	93
	Max Start-Up	140
Input Speed	Max (rpm)	3000
Thermal Limit	Power (kW)	3.3
Backlash	arcmin	9 to 16
Efficiency	(%)	95% - 98%
Service Life	(hours)	>10000
Housing Material		SG Iron
Oil Quantity	Litres	0.14
	Pints	0.24
Weight (kg)	2 Way - 1:1 & 1.5:1	4.5
	3 Way - 1:1 & 1.5:1	4.75

Notes:

#1 Nominal torque values at running speeds of 1500 rpm
#2 Maximum running torque value at speed of 10 rpm
Full detailed performance for each unit refer to page 12 & 13

Accessories & Options

	Special Gear Ratio		Motor Flange
	Extended Drive Shaft		Limit Switches
	Drives		Light Weight Design
	Reinforced Shaft OR High Torque		Breather
	90° Breather		Mounting Feet
	Shaft Cover		Stainless Steel
	Submersible		Corrosion Protection
	Nuclear Rated		Food Grade
	Low Temperature		High Temperature

2 Way Solid Shaft

N350S20-20

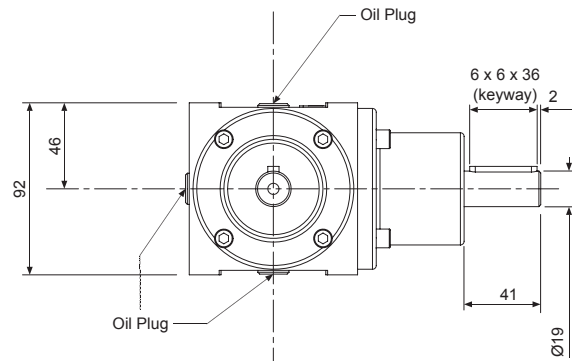
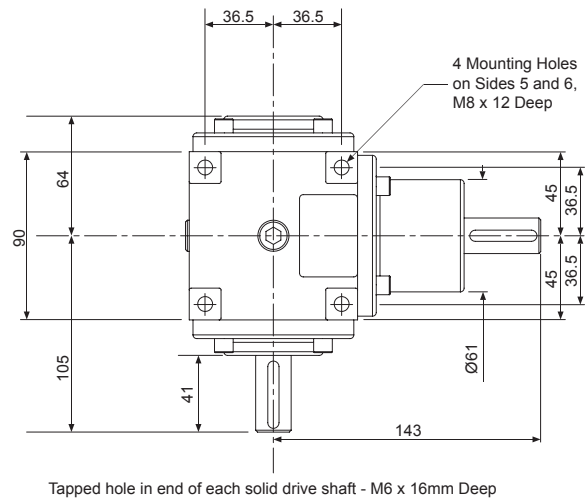
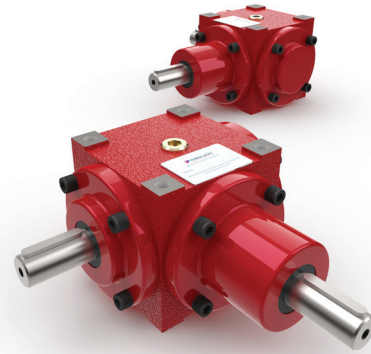

Notes:

1. All dimensions in mm unless otherwise stated
2. Dimensions subject to change without notice